

Curves

Dr Richard Kenderdine

Kenderdine Maths Tutoring

16 December 2014

This note shows some interesting curves not usually encountered. Most of the examples exist as families that can be altered by changing parameters whose values are shown on sliders at the top of the graphic. *Mathematica* was used to generate the graphics.

Right strophoid

The right strophoid is defined by

$$x(t) = -2a \left(\frac{1-t^2}{1+t^2} \right), \quad y(t) = -2at \left(\frac{1-t^2}{1+t^2} \right) \quad (1)$$

with $a > 0$. The curve is at the origin for two values of t ($\neq 1$); it is said to have a 'self-crossing' at the origin. The asymptote is at $x = 2a$.

The following plots show the curve for various values of a :

```
Manipulate[ParametricPlot[{-2 a (1 - t^2) / (1 + t^2), -2 a t / (1 + t^2)}, {t, -2, 2},  
PlotRange -> {{-4, 4}, {-4, 4}}, {a, 0, 2, 0.1, Appearance -> "Labeled"}]
```

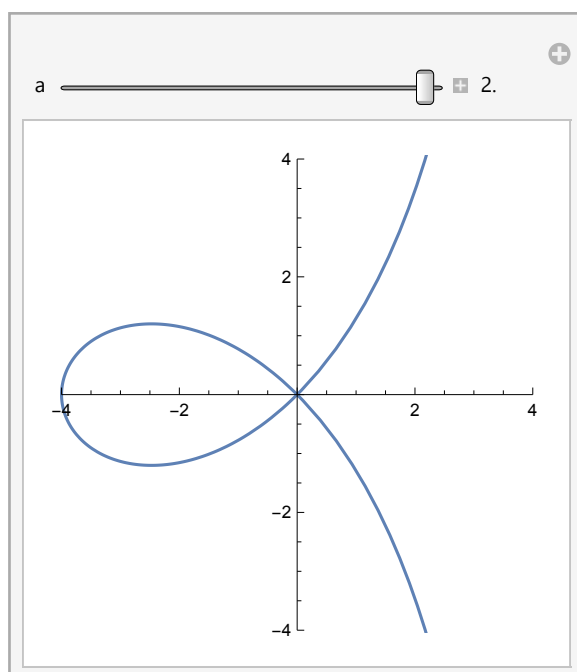
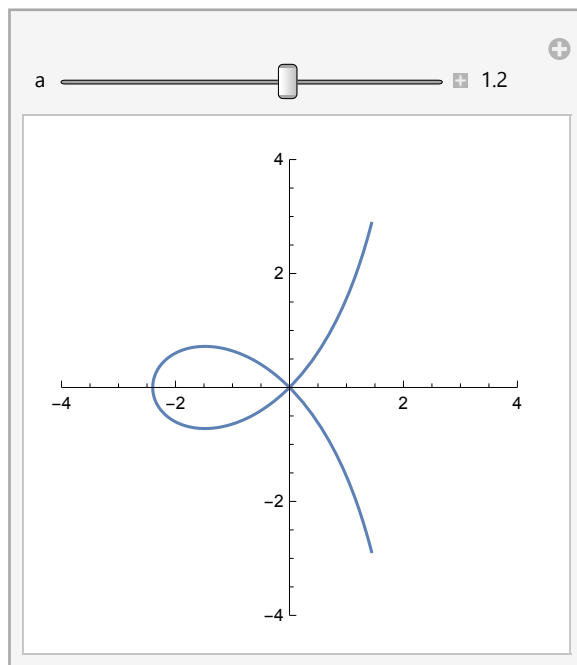

Maclaurin's trisectrix

This curve is similar to the right strophoid but only has one form, defined in parametric form as:

$$x(t) = \frac{t^2 - 3}{1 + t^2}, \quad y(t) = \frac{t(t^2 - 3)}{1 + t^2} \quad (2)$$

or, showing explicitly that there is an asymptote at $x = 1$ and x-intercepts at $x = -3$ and 0 ,

$$y^2 = x^2 \left(\frac{3+x}{1-x} \right) \quad (3)$$

```
ParametricPlot[{{ $\frac{t^2 - 3}{1 + t^2}$ ,  $\frac{t(t^2 - 3)}{1 + t^2}$ }, {t, -10, 10},
PlotRange -> {{-4, 1}, {-5, 5}}, AspectRatio -> 0.5]
```

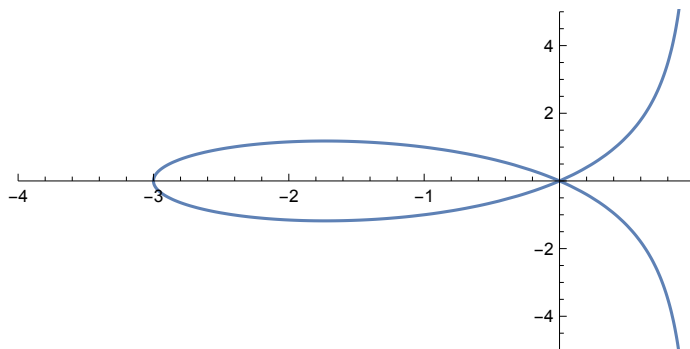

Agnesi's versiera

This curve is the locus of points arising from the following:

Consider the circle of radius a centred at $(0, a)$. The line $x = t y$ through the origin intersects the circle at point P and the line $y = 2a$ at point Q . The locus of the intersection of the horizontal line through P and the vertical line through Q produces the curve which has parametric form:

$$x(t) = 2 a t, \quad y(t) = \frac{2 a}{1 + t^2} \quad (4)$$

The plots for curves with varying values of a are:

```
Manipulate[ParametricPlot[{{ $2 a t$ ,  $\frac{2}{1 + t^2}$ },
{t, -4, 4}, PlotRange -> {{-8, 8}, {0, 2.2}}, AspectRatio -> 0.5],
{a, 0, 4, 0.1, Appearance -> "Labeled"}]
```

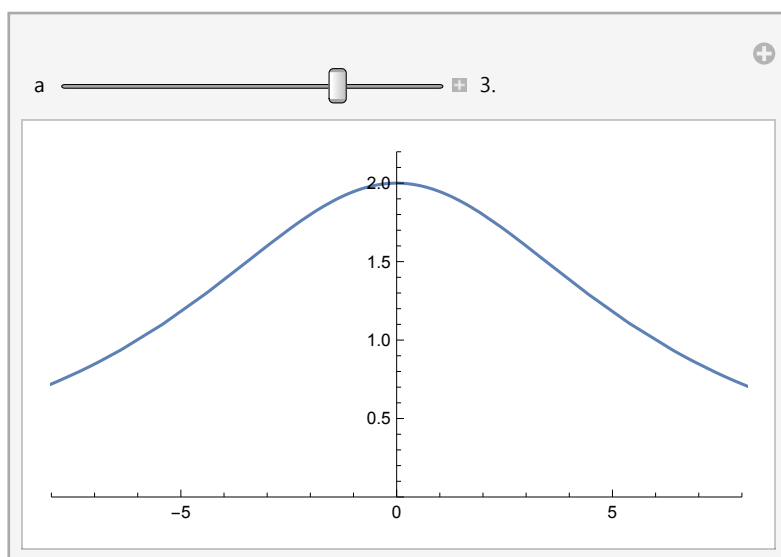
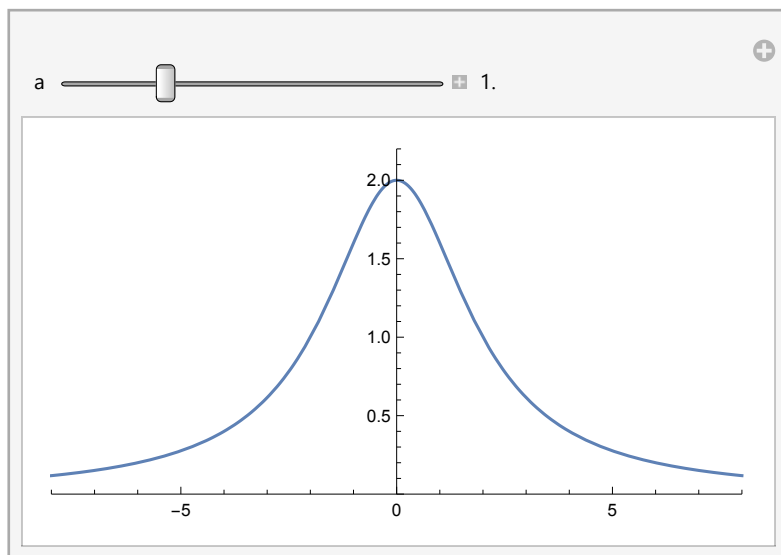
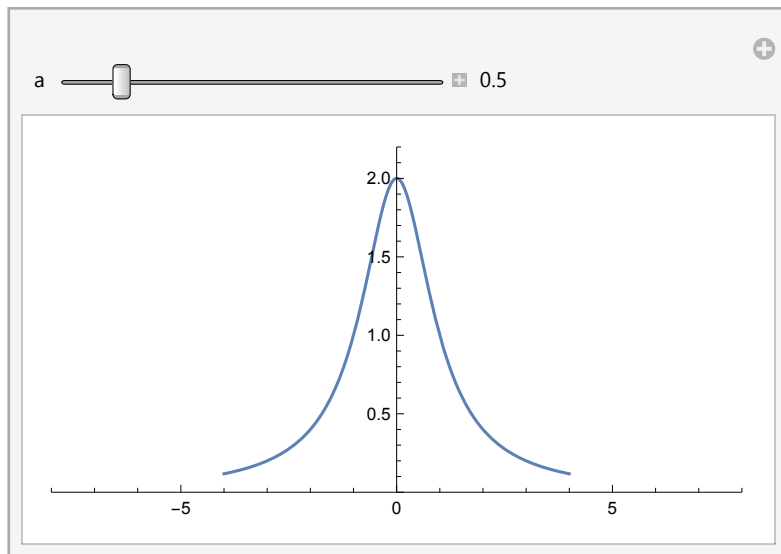

Rose curves

The general equation for this family of curves is

$$z(t) = 2 b e^{i t} \cos(nt) \quad (5)$$

or

$$x(t) = 2 b \cos(t) \cos(nt), \quad y(t) = 2 b \sin(t) \cos(nt) \quad (6)$$

The curves lie inside the circle of radius $2b$, centered at the origin. When n is a positive integer the curves are known as *clover leaves* and touch the bounding circle at the $2n^{\text{th}}$ roots of unity. When n is even there are $2n$ points of contact and when n is odd there are n points of contact.

The following plots show the curves various values of n and b :

```
Manipulate[ParametricPlot[
  {Re[ComplexExpand[2 b e^{i t} Cos[n t]]], Im[ComplexExpand[2 b e^{i t} Cos[n t]]]},
  {t, 0, 8 π}, PlotRange -> {{-4, 4}, {-4, 4}},
  {n, 0, 5, 0.1, Appearance -> "Labeled"}, {b, 0, 2, 0.5, Appearance -> "Labeled"}]
```

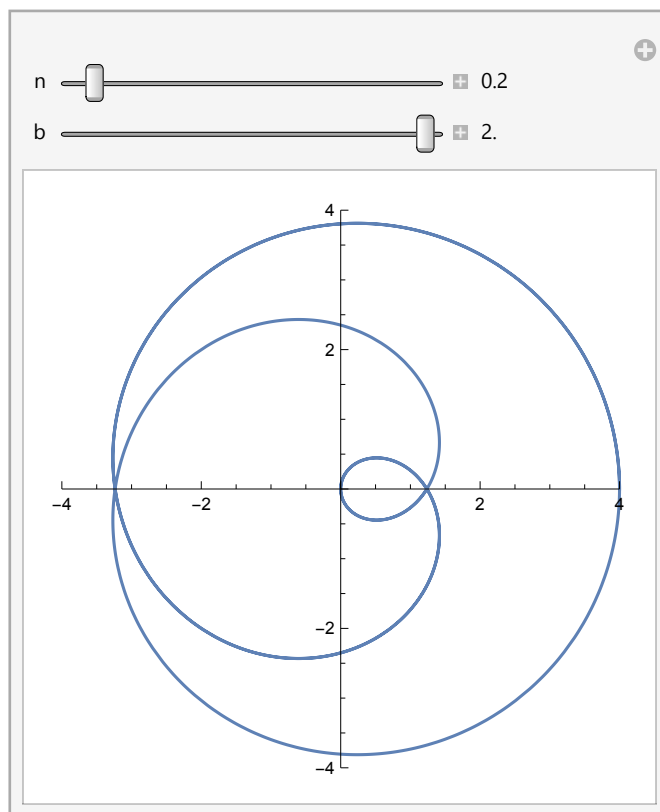

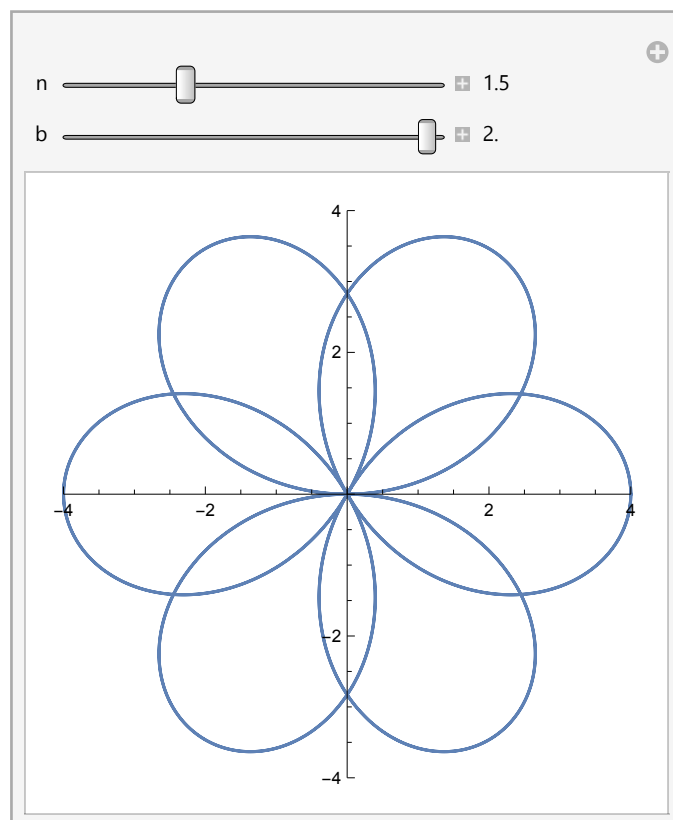
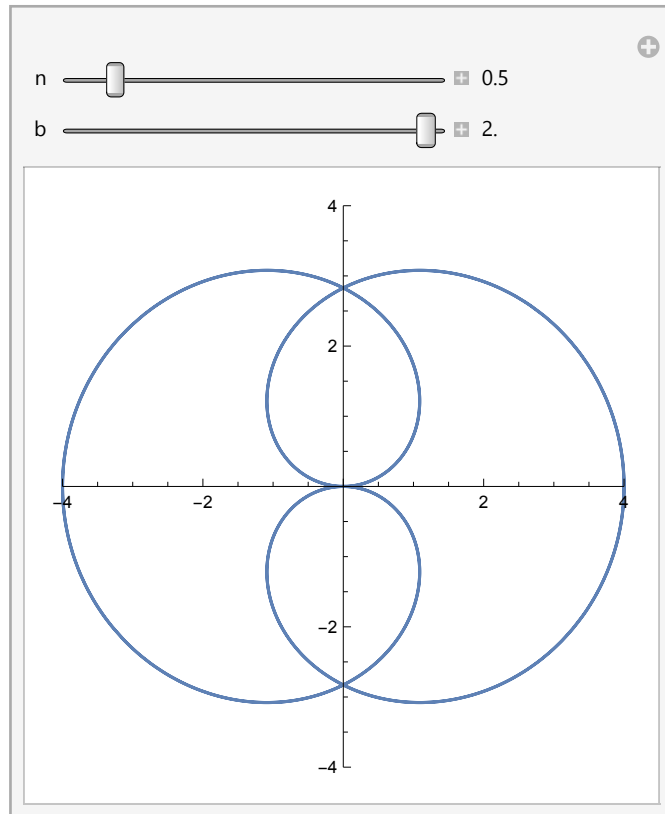

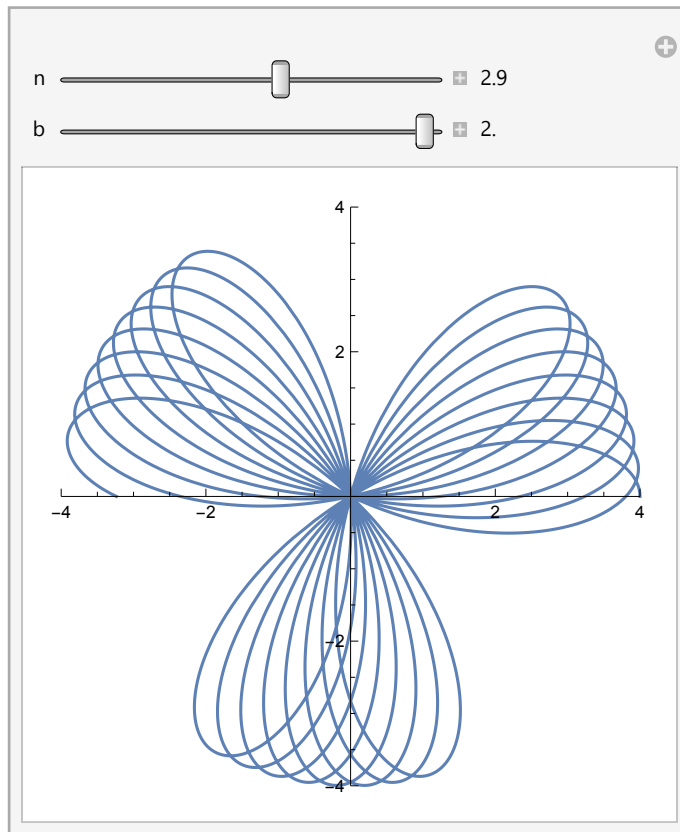
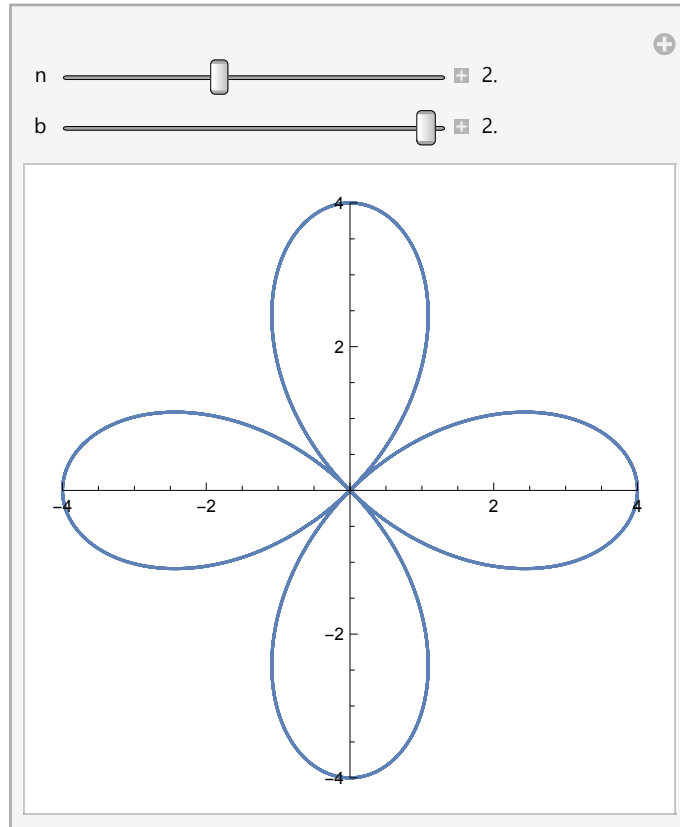

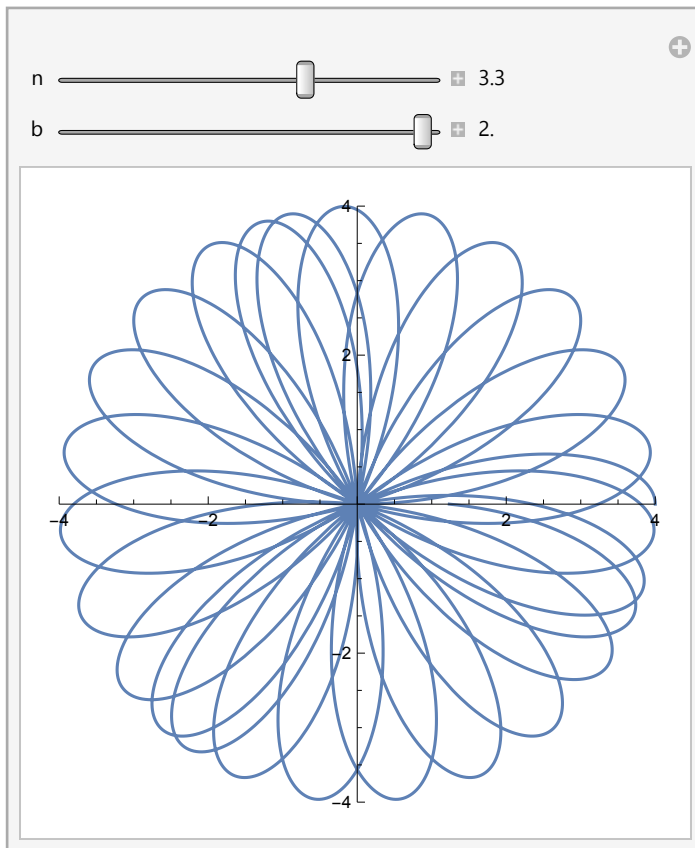
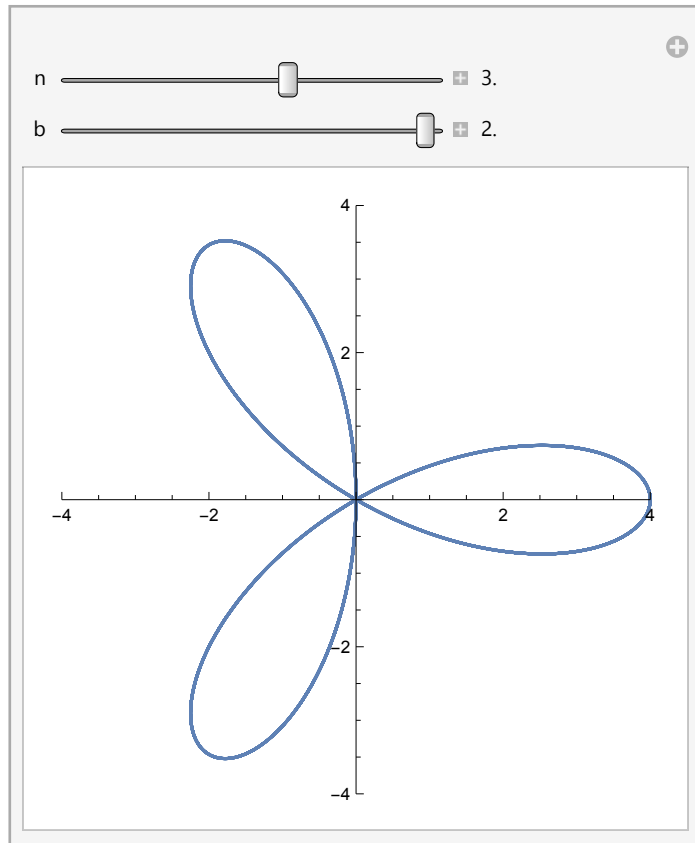

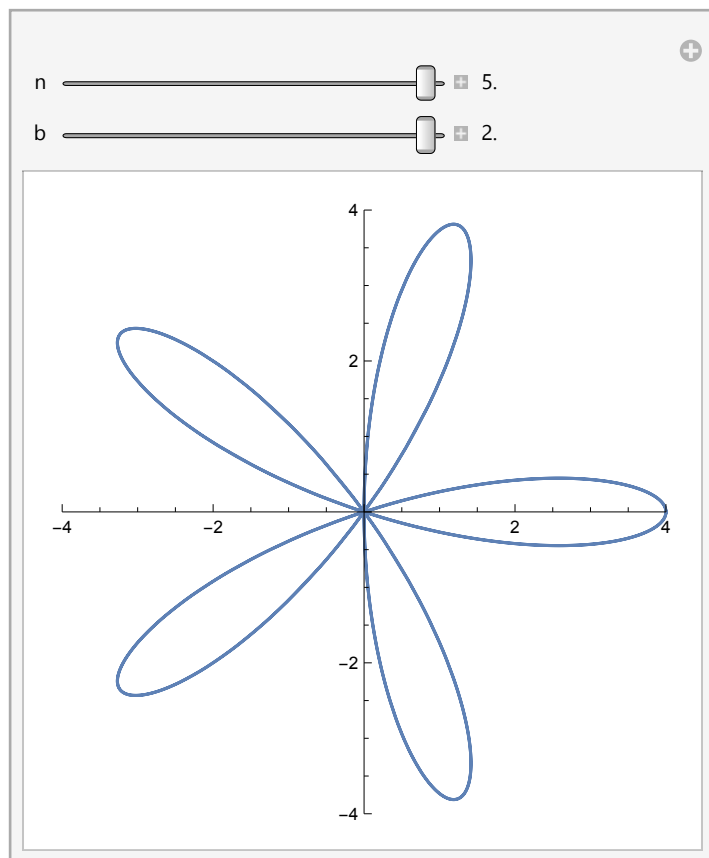
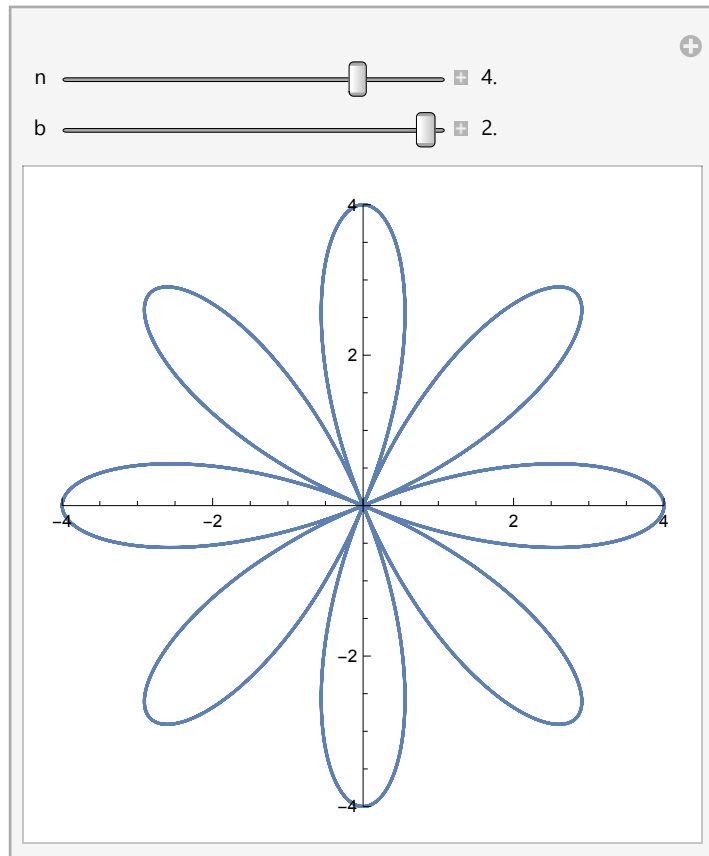

Epicycloids ($\lambda > 0$) and Hypocycloids ($\lambda < 0$)

A *trochoid* is a curve traced out by a point on or within a circle of radius R' that rotates around a fixed circle of radius R . If the point is on the circle the resulting curves are termed *epicycloids* or *hypocycloids*, depending upon the ratio of the radii of the two circles. The ratio, $\frac{R'}{R}$, is denoted by λ and is negative if the moving circle is rotating inside the fixed circle, positive if it is outside the circle.

The parametric equation is

$$z(t) = (\lambda + 1) e^{it} - e^{i(\lambda+1)t} \quad (7)$$

or, in terms of real and imaginary components,

$$x(t) = (\lambda + 1) \cos(t) - \cos((\lambda + 1)t), \quad y(t) = (\lambda + 1) \sin(t) - \sin((\lambda + 1)t) \quad (8)$$

The following plots show curves obtained for various values of λ :

```
Manipulate[ParametricPlot[{Re[ComplexExpand[(λ + 1) e^{i t} - e^{i (λ+1) t}]],
  Im[ComplexExpand[(λ + 1) e^{i t} - e^{i (λ+1) t}]]}, {t, 0, 4 π},
  PlotRange -> {{-6, 6}, {-6, 6}}, {λ, -4, 4, 0.5, Appearance -> "Labeled"}]
```

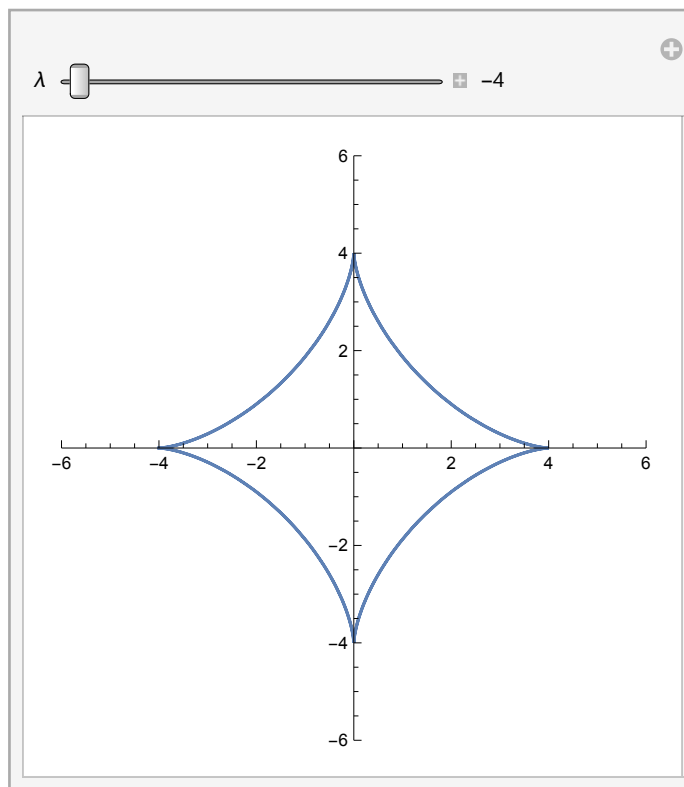

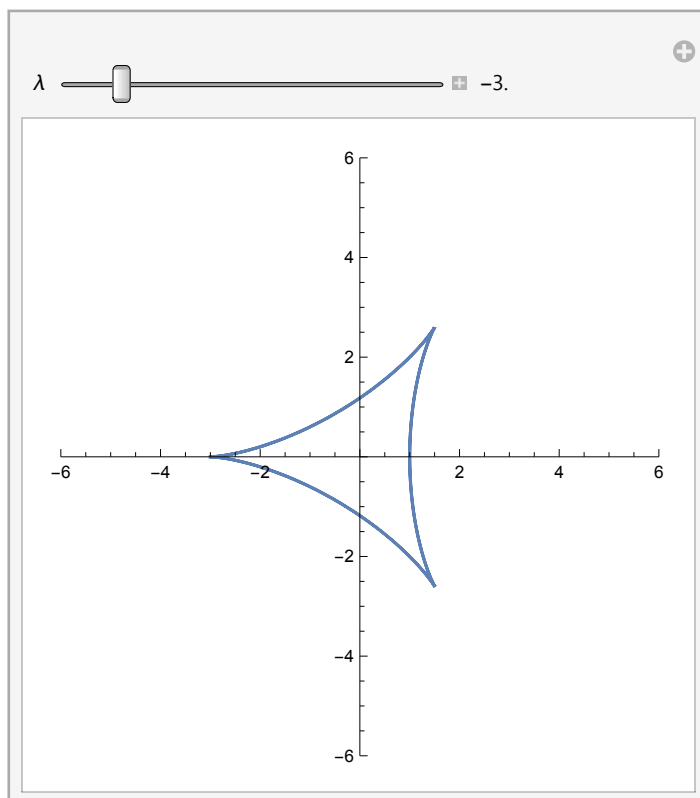
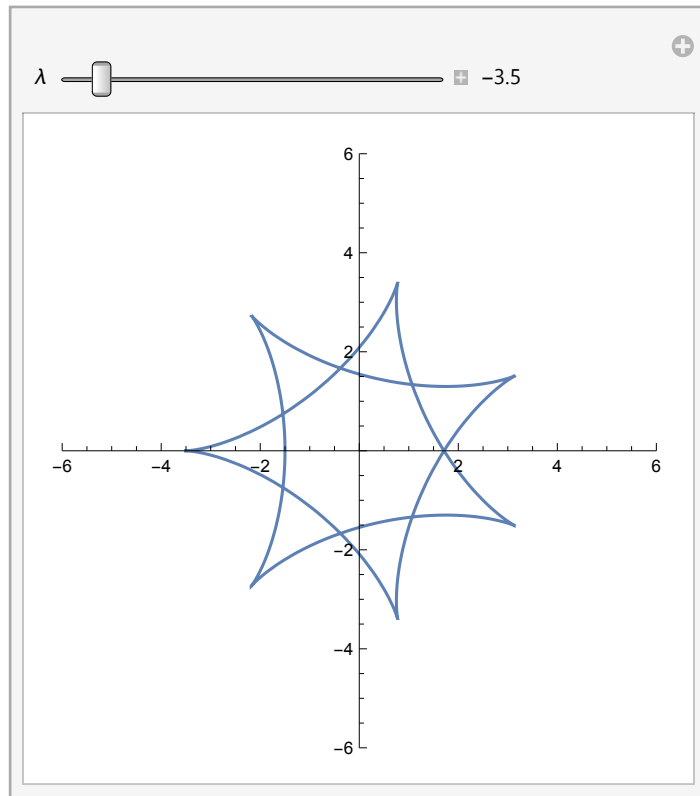

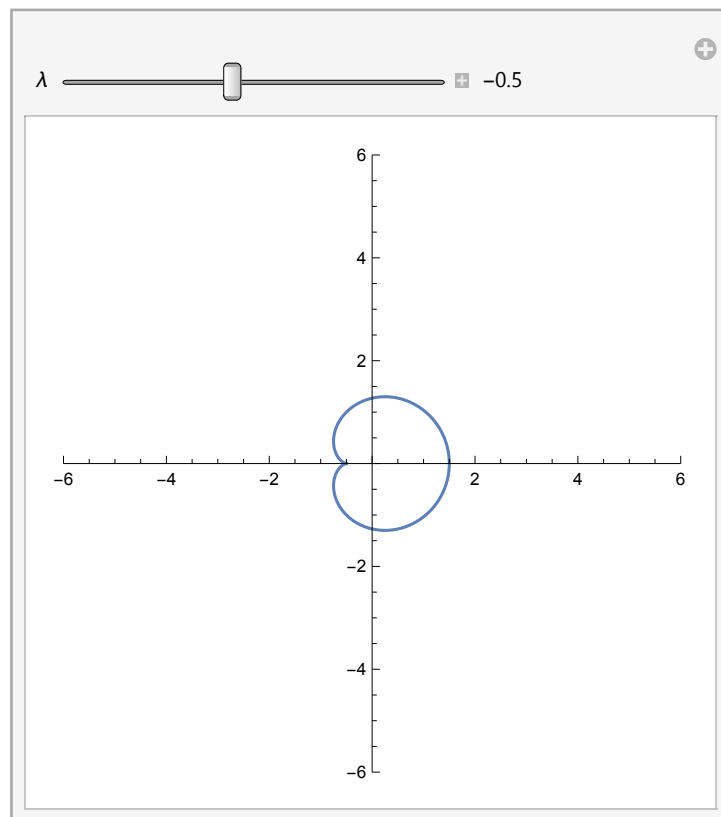
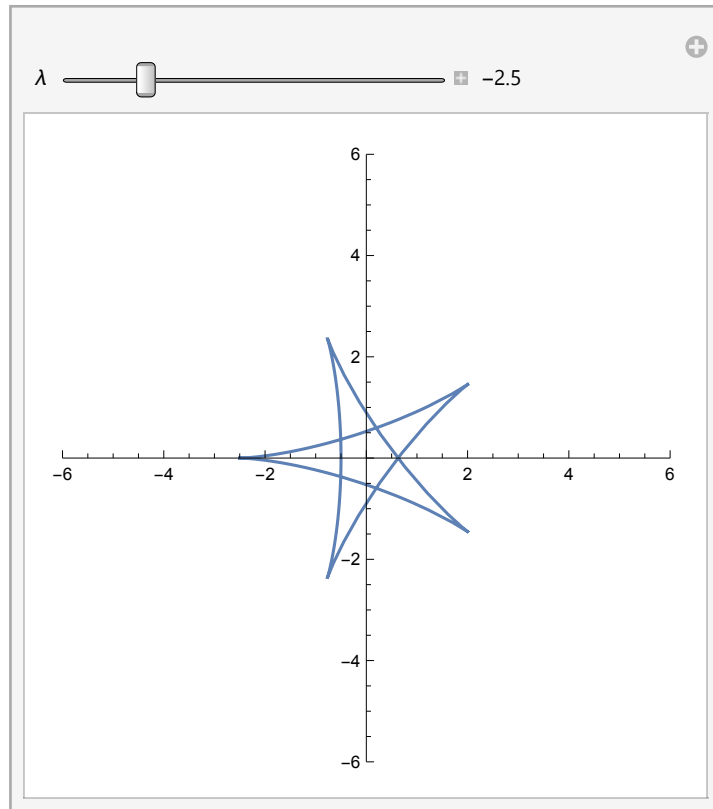

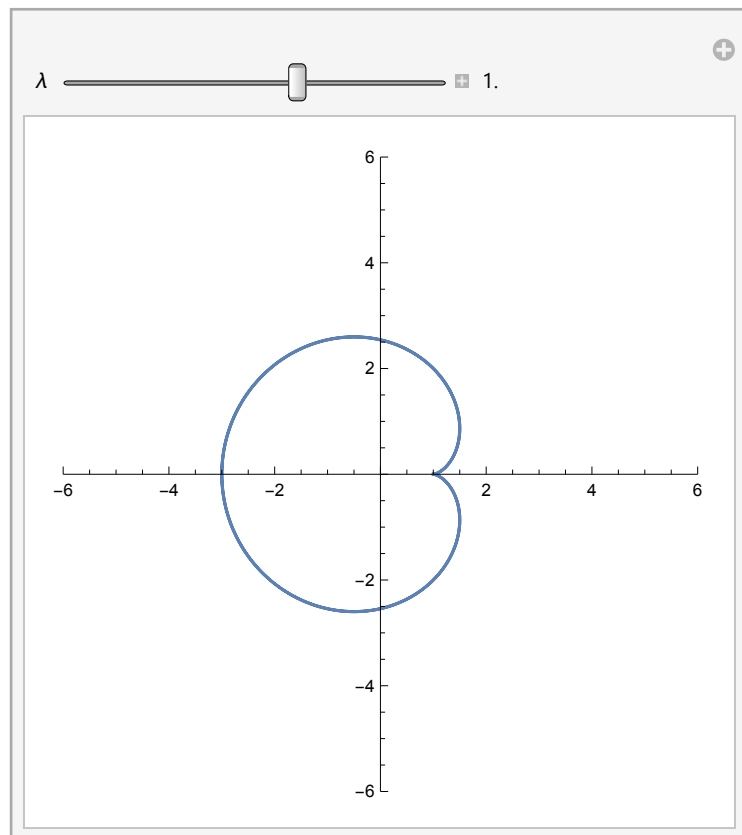
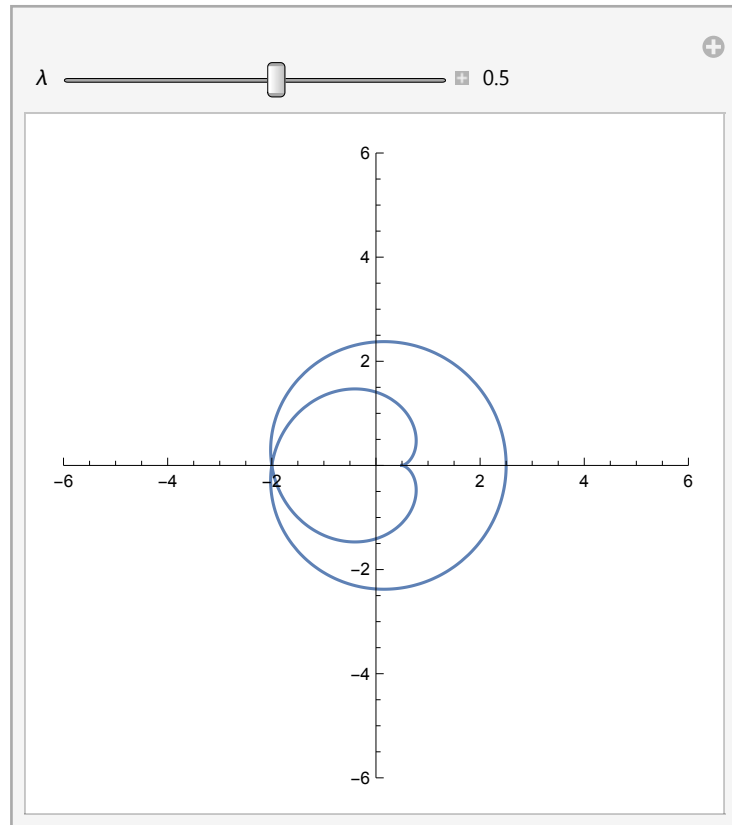

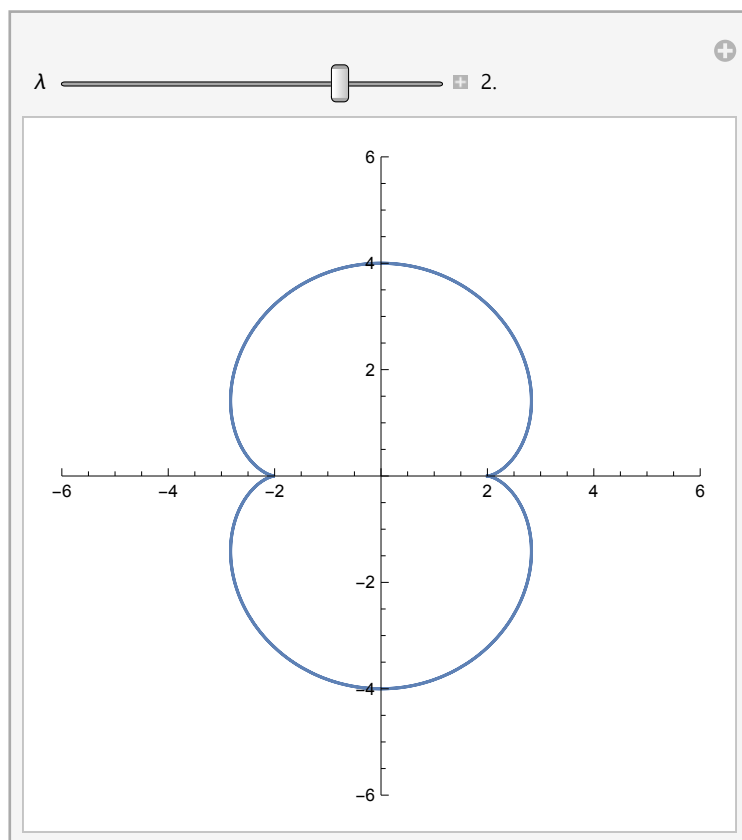
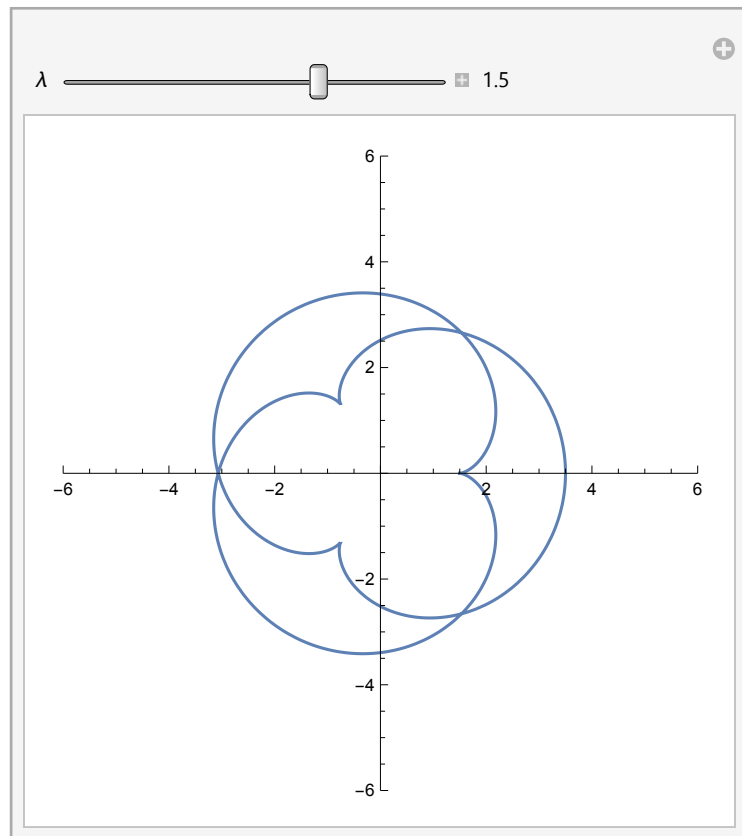

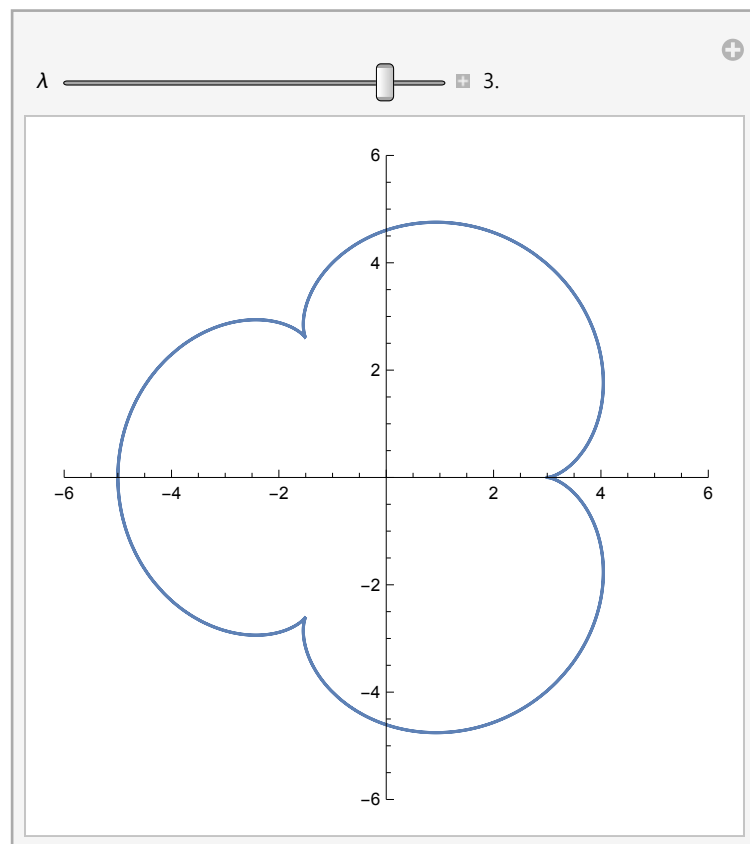
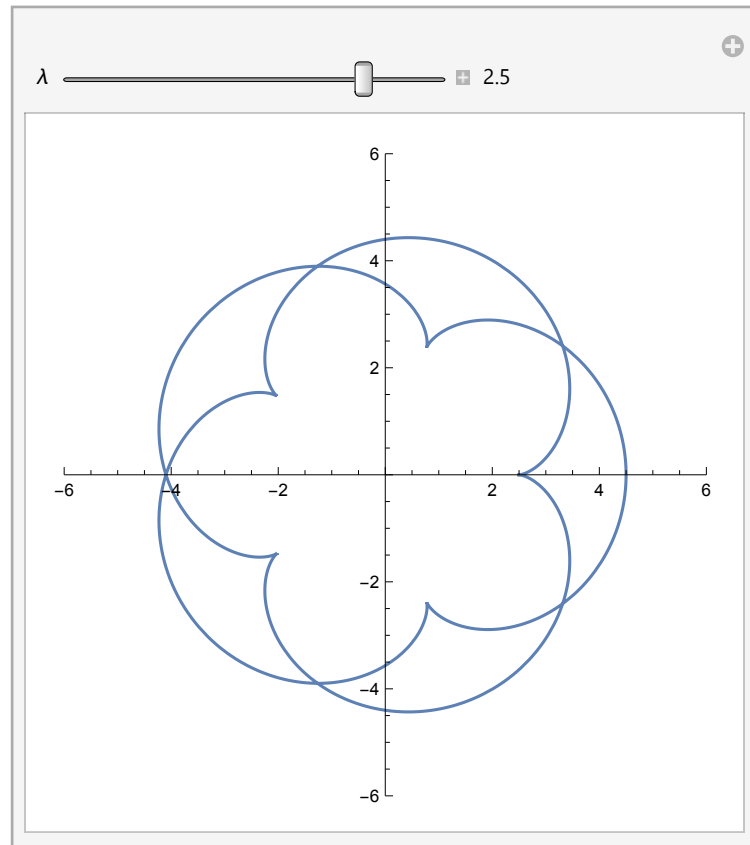

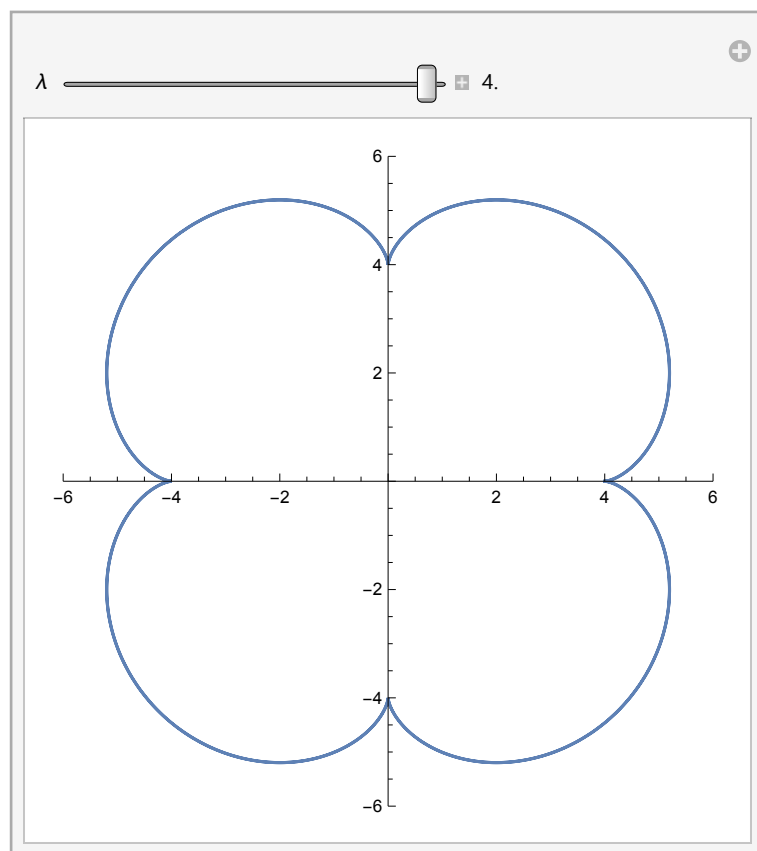
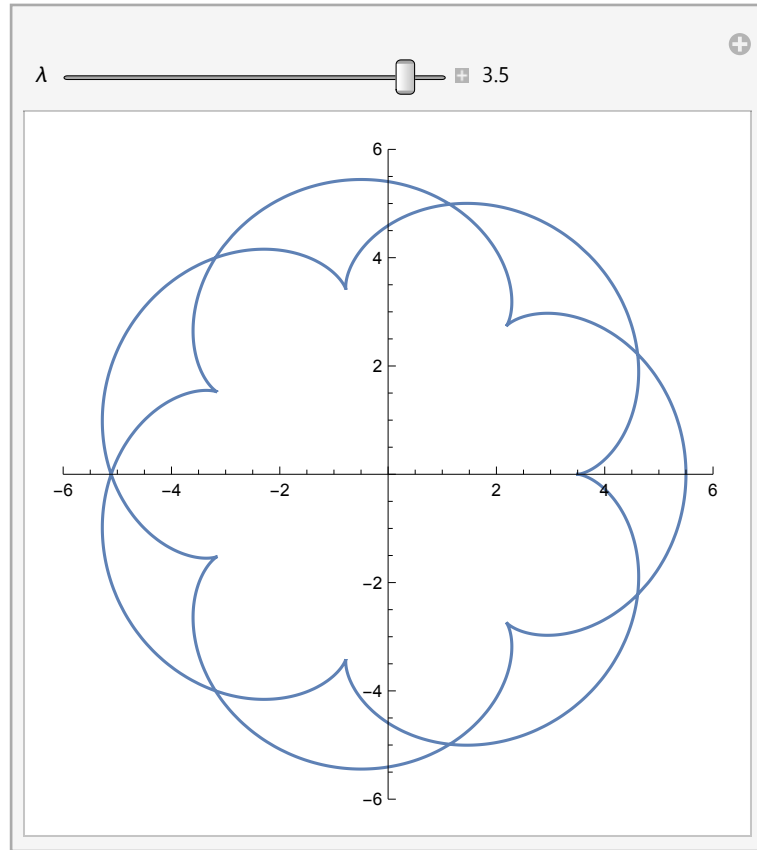

Limacon

The limaçon is a special case of a trochoid when the circles have equal radii. The parametric equation is then:

$$z(t) = 2e^{it} - he^{2it} \quad (9)$$

or as components

$$x(t) = 2 \cos(t) - h \cos(2t), \quad y(t) = 2 \sin(t) - h \sin(2t) \quad (10)$$

When $h = 1$ the curve is called a *cardioid*. The plots show curves for various values of h :

```
Manipulate[ParametricPlot[{2 Cos[t] - h Cos[2 t], 2 Sin[t] - h Sin[2 t]},
  {t, 0, 2 π}, PlotRange → {{-6, 6}, {-6, 6}},
  {h, 0, 4, 0.1, Appearance -> "Labeled"}]
```

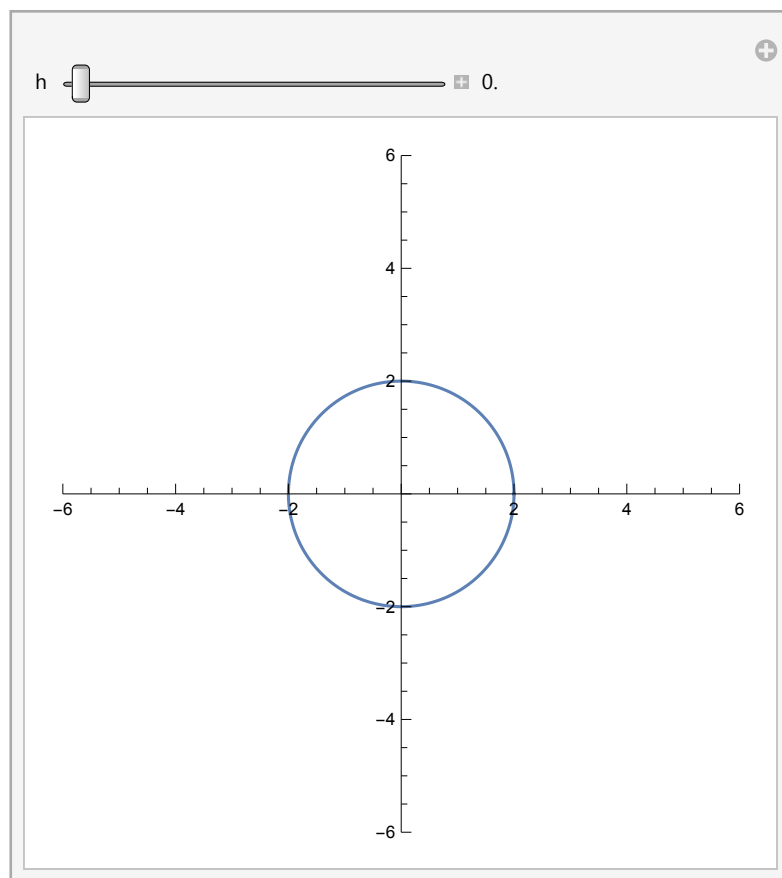

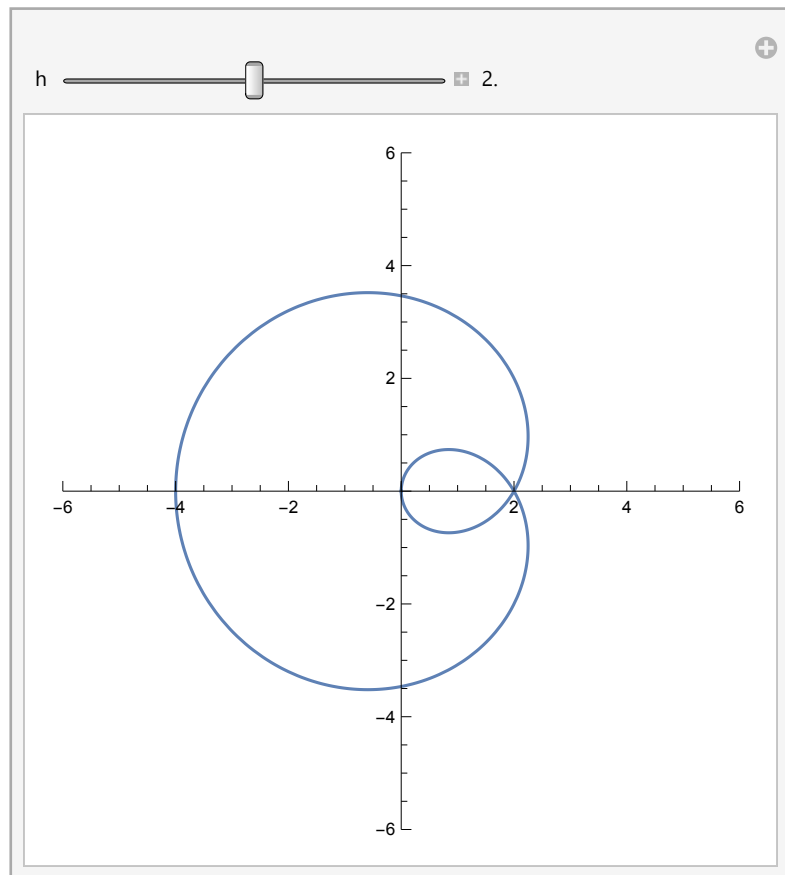
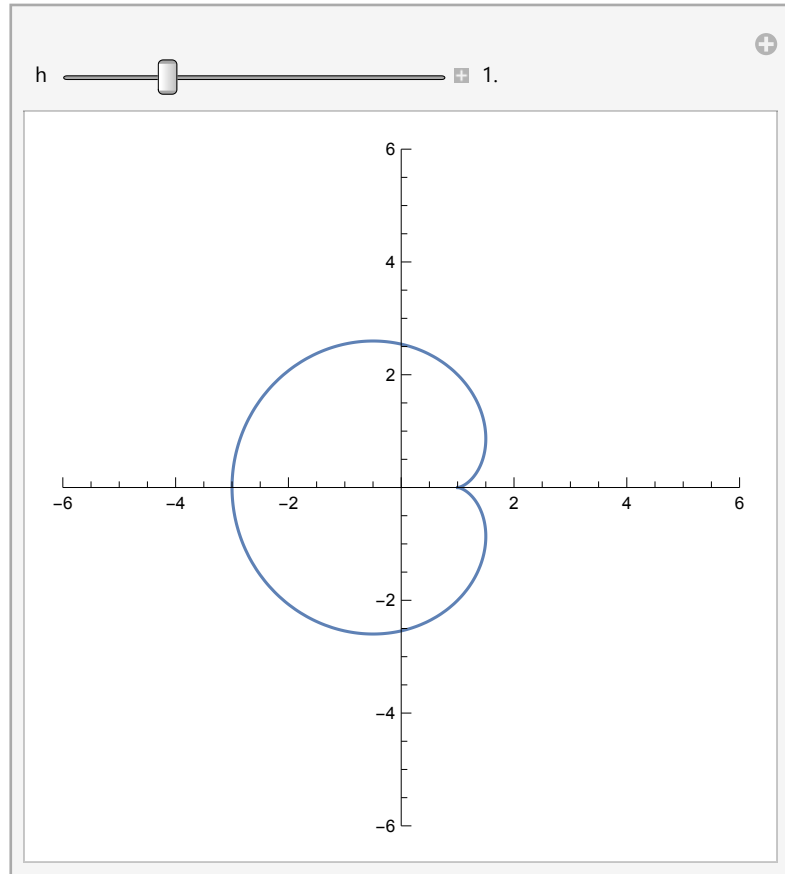

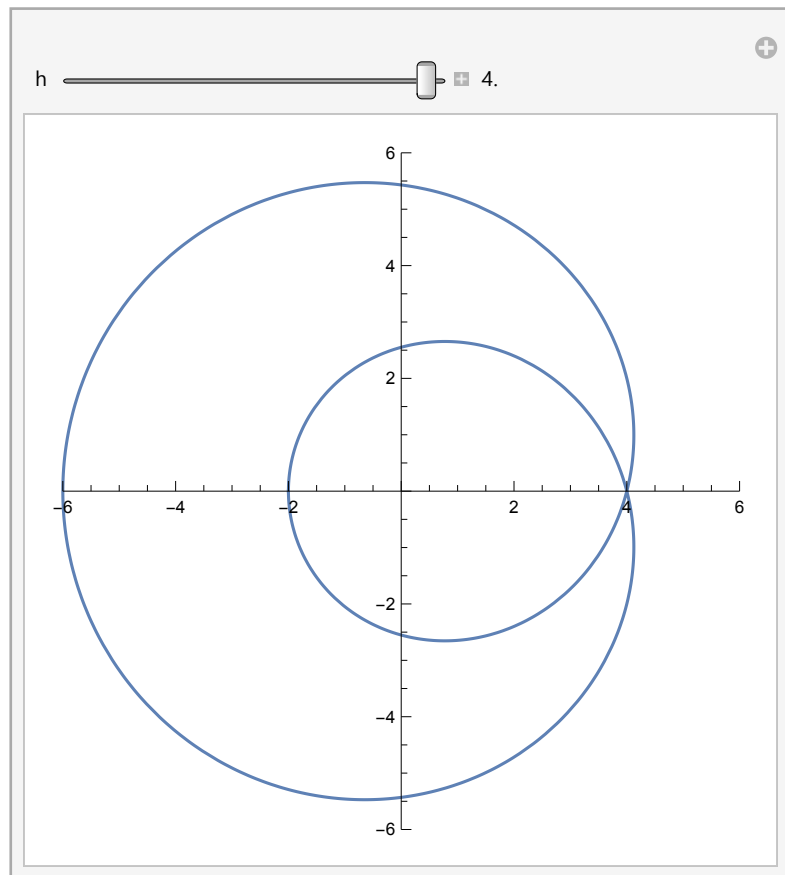
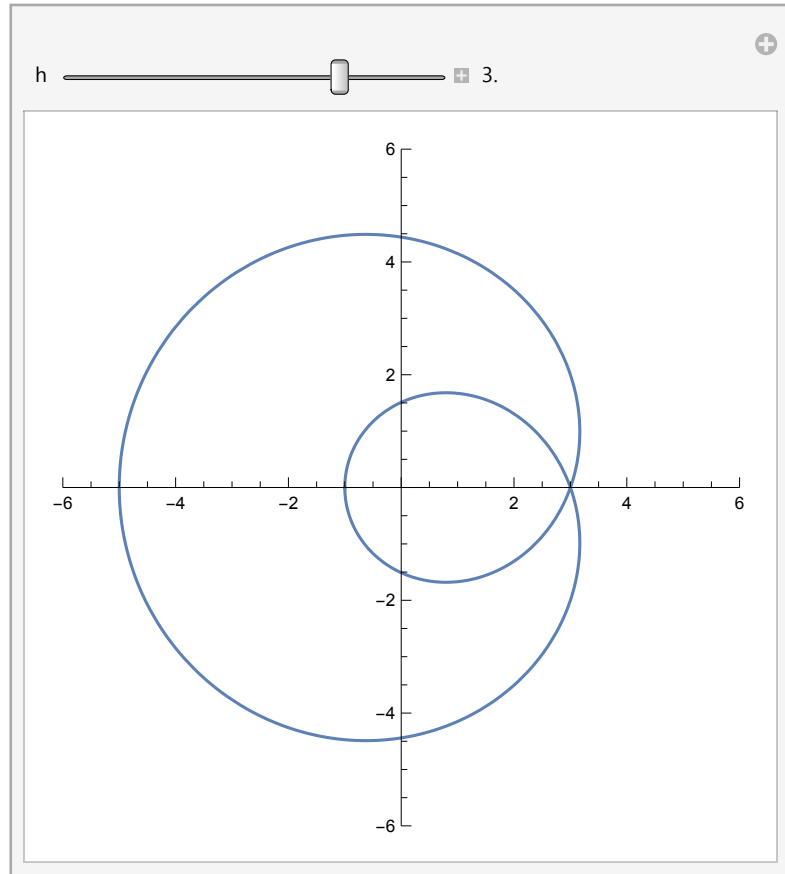

The piriform

The piriform is the locus of all points found from the following construction:

Consider the circle with centre $(a, 0)$ and radius a and the line L given by $x = \frac{a^2}{b}$. For any point P on the circle, let Q be the intersection of L and the horizontal line through P . Let R be the intersection of the vertical line through P and the line joining Q to the origin. The locus of R is the piriform which has parametric form:

$$x(t) = a(1 + \cos(t)), \quad y(t) = b \sin(t) (1 + \cos(t)) \quad (11)$$

Note that a stretches the curve horizontally while b stretches it vertically.

```
Manipulate[ParametricPlot[{a (1 + Cos[t]), b Sin[t] (1 + Cos[t])},
  {t, 0, 2 π}, PlotRange -> {{0, 3}, {-3, 3}}, AspectRatio -> 0.5],
  {a, 0, 1.5, 0.1, Appearance -> "Labeled"},
  {b, 0, 2, 0.1, Appearance -> "Labeled"}]
```

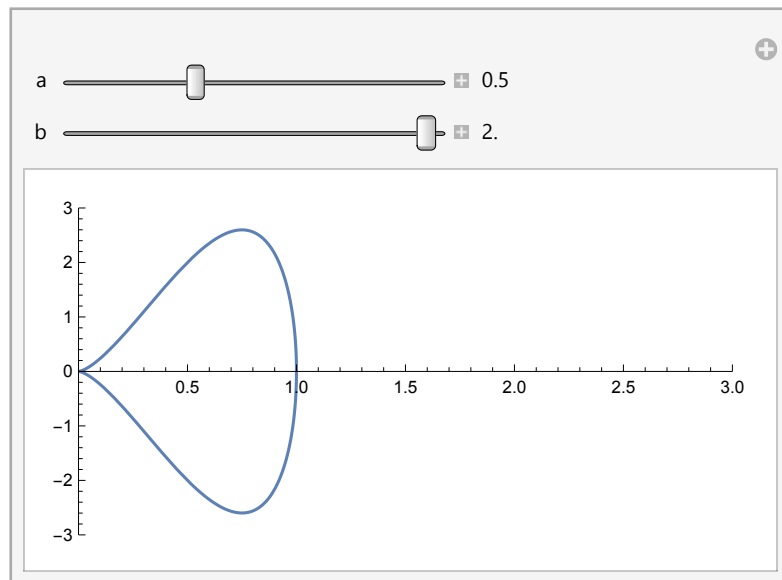

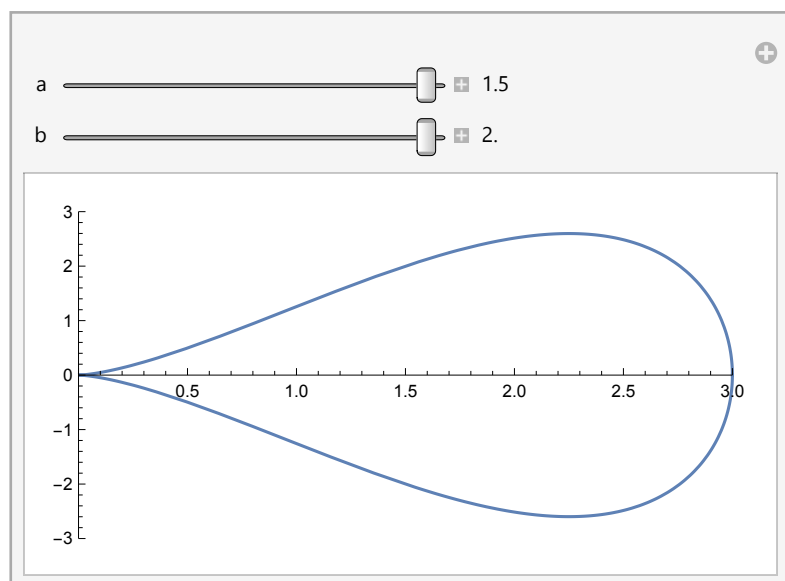
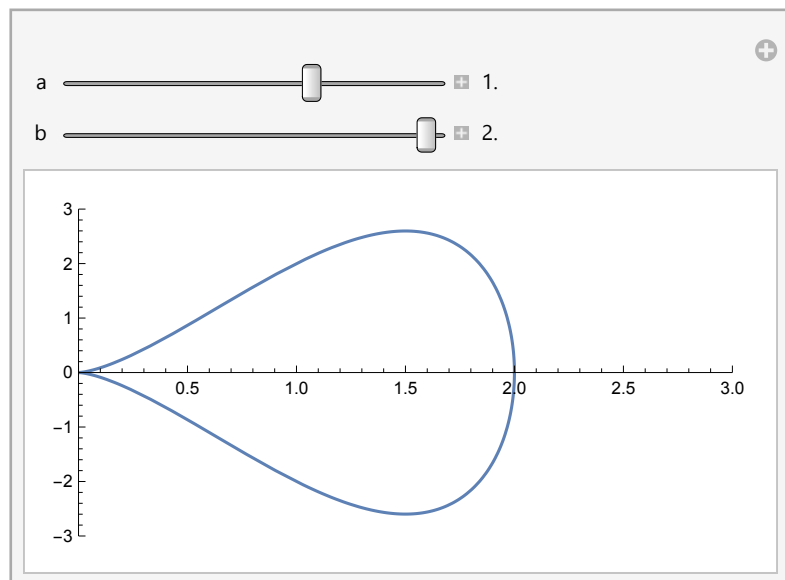
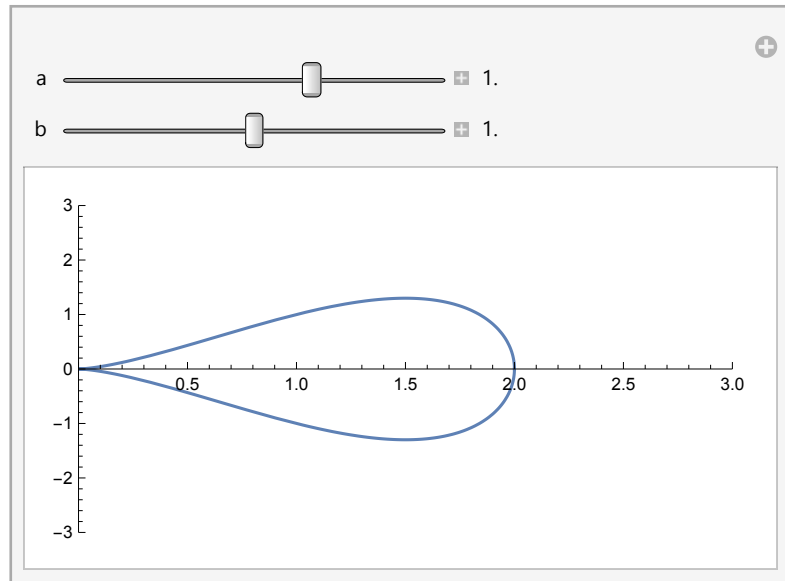

Reference

Elementary Geometry of Differentiable Curves, CG Gibson, Cambridge University Press, 2001